

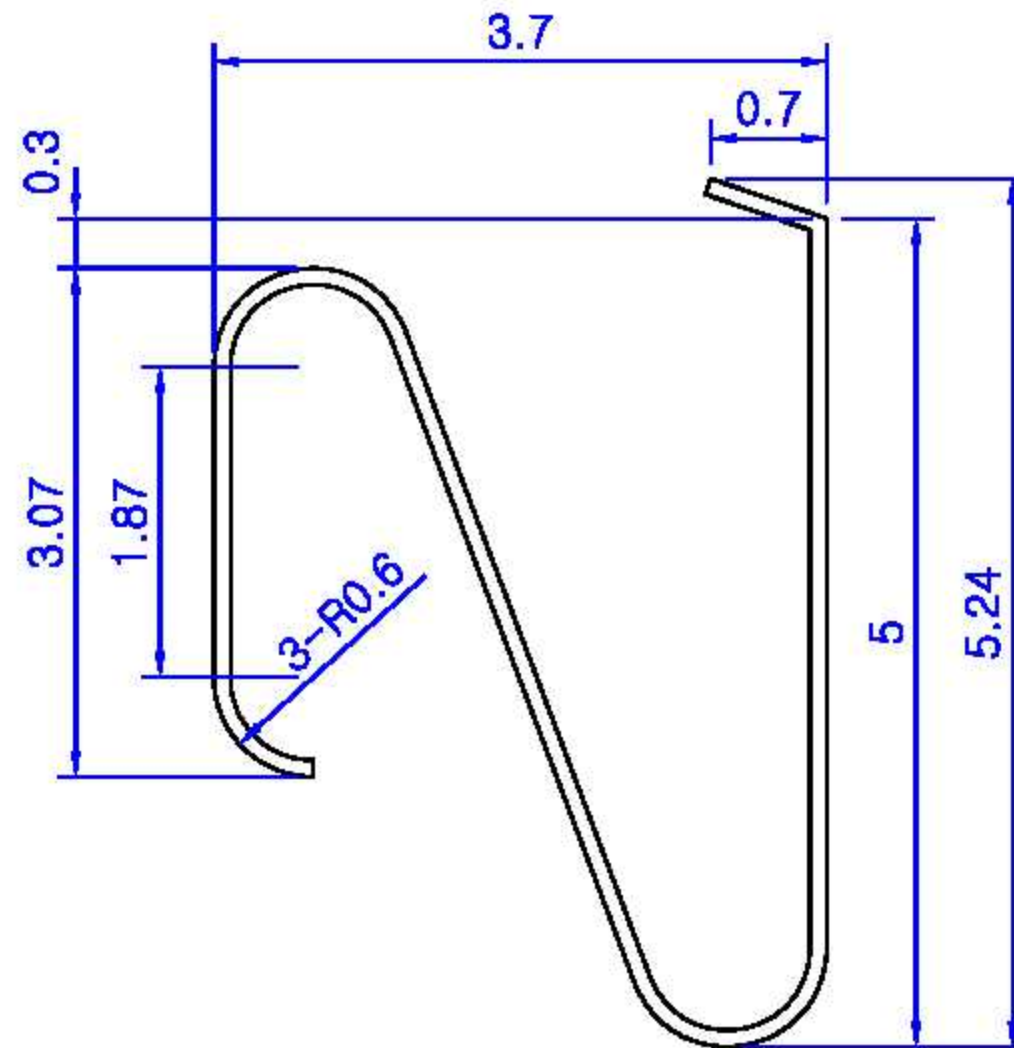

No	Name	Material	Remark
1	SMD finger	SUS 301 0.1t	
2			
3			
4			

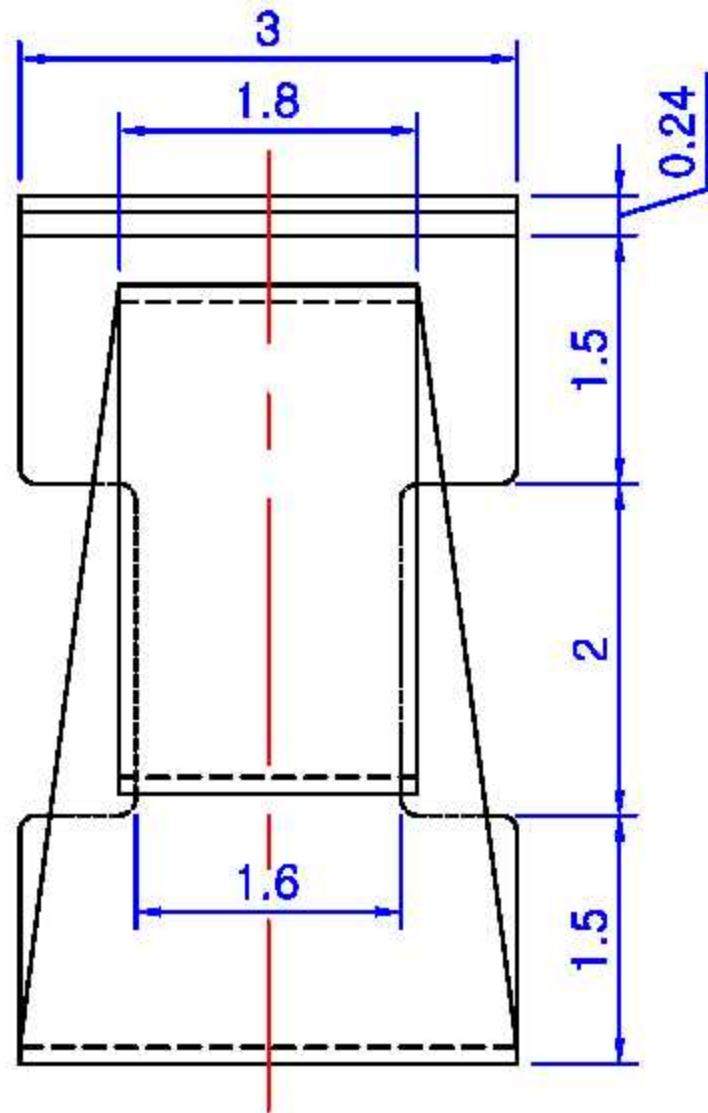

Designed by	Reviewed by	Approved by	Rev	Date	Description	Revised	Checked	Part No	F851	TITLE	SMD FINGER
								DWG No	ES-DWG00	Form	
								Unit	mm	General Tolerance	
2007. . .	2007. . .	2007. . .						SCALE		PROJECTION	
											E-Song America, Inc. www.esongamerica.com