

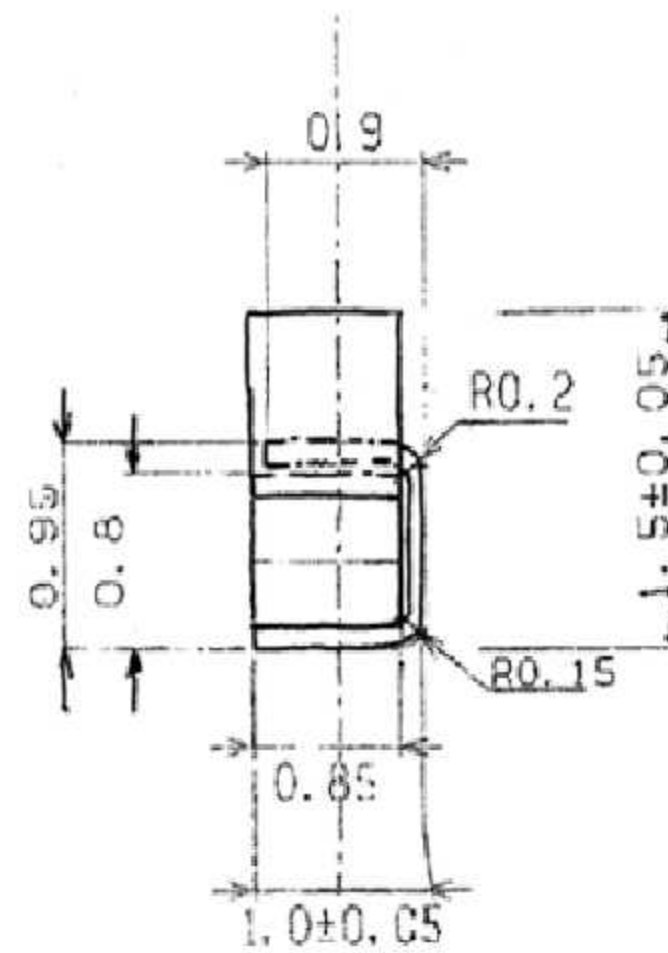

No	Name	Material	Remark
1	Finger Strip	BeCu 0.10t	
2			
3			
4			

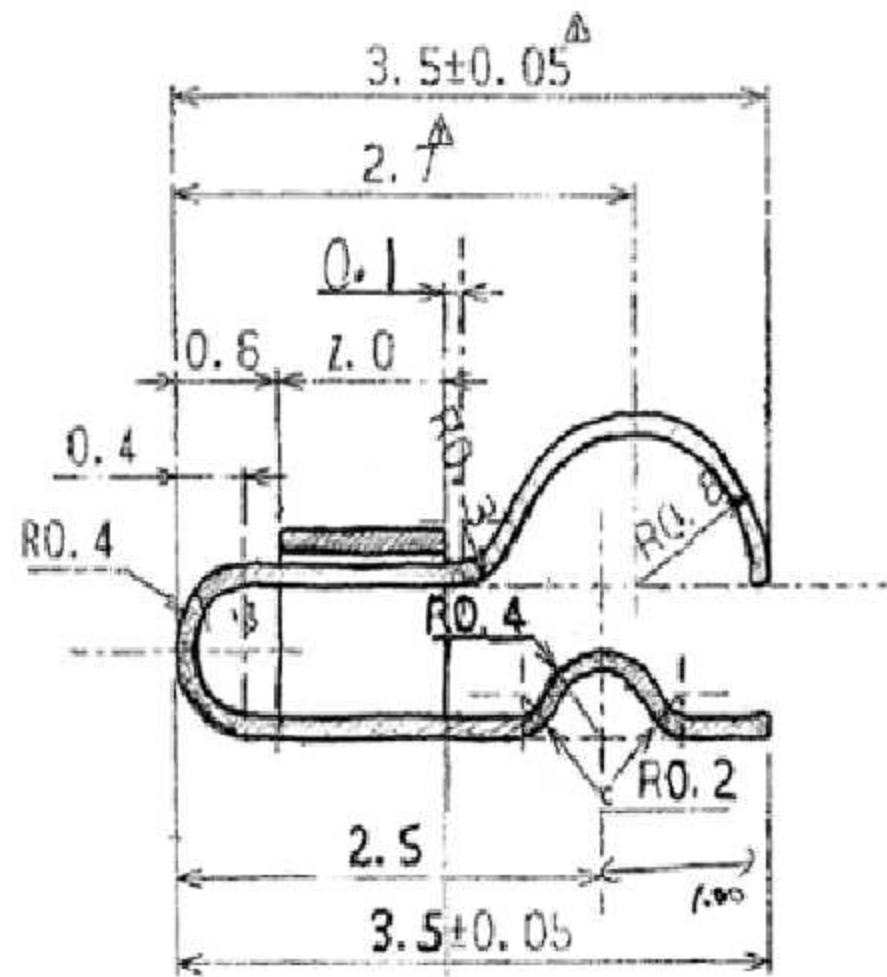

Designed by	Reviewed by	Approved by	Rev	Date	Description	Revised	Checked	Part No	FEA649	TITLE	FINGER STRIP
								DWG No		Form	
								Unit	mm	General Tolerance	
2007. . .	2007. . .	2007. . .						SCALE		PROJECTION	  E-Song America, Inc.